

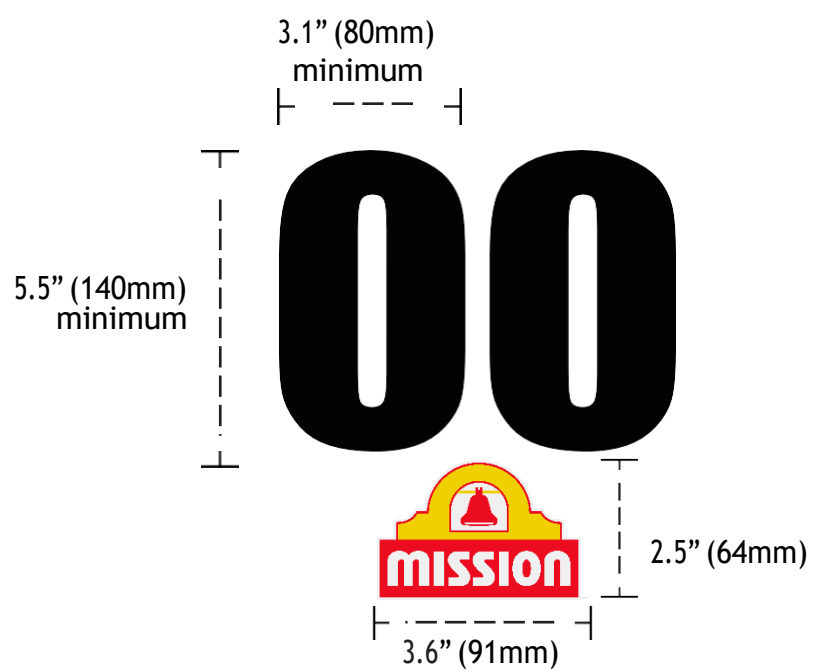

2025 SEASON

MISSION KING OF THE BAGGERS CLASS

**NUMBER AND MOTORCYCLE LOGO GUIDELINE. RIDER SUIT AND
CREW SHIRT REQUIREMENTS COMPETITOR BULLETIN 02-2025**

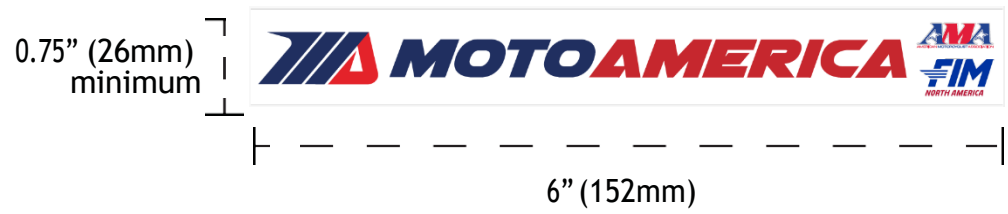
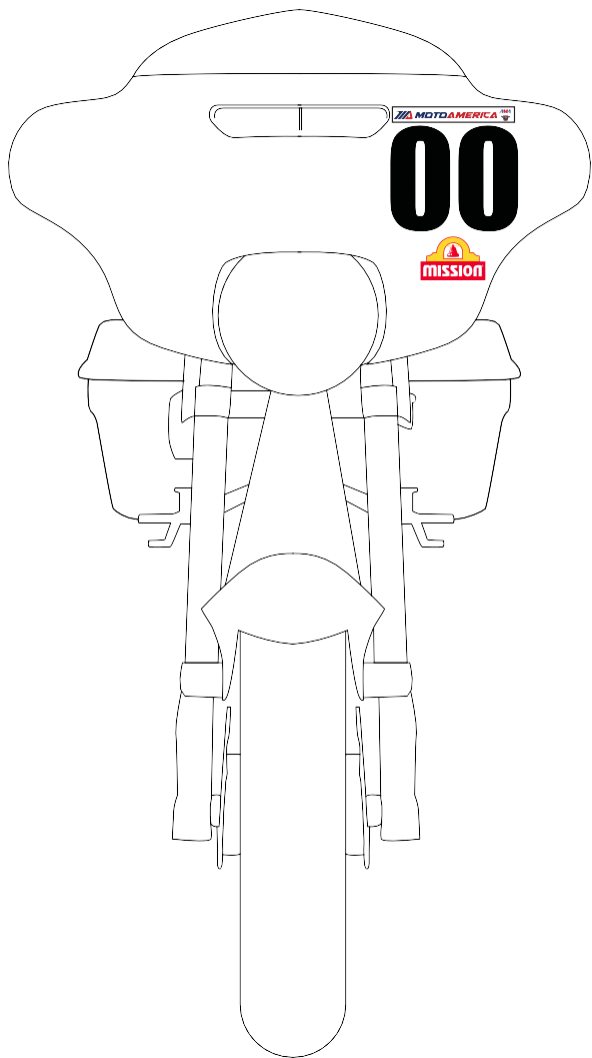

* minimum stroke is 0.75" (20mm)
** minimum space between numbers is 0.40" (10mm)

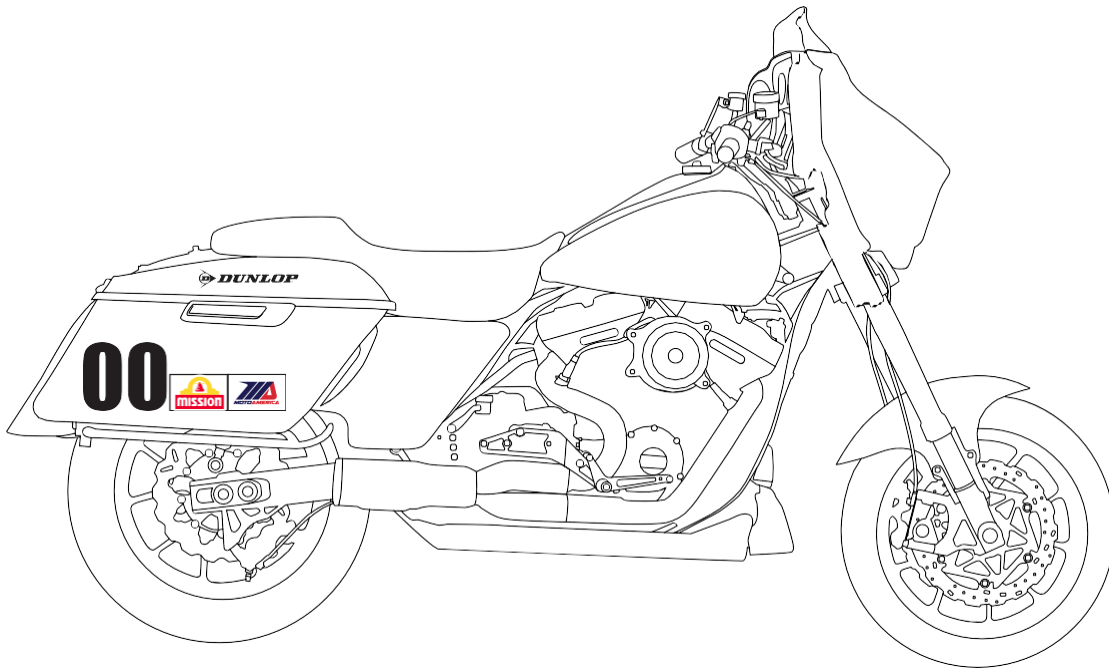

2.75" (70mm)
minimum

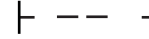

4.75" (120mm)
minimum

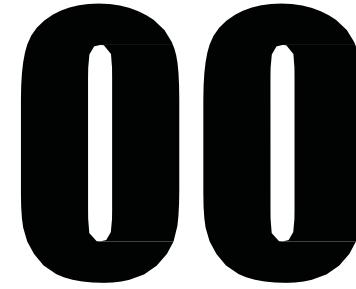
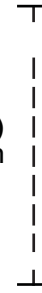

* minimum stroke is 0.75" (20mm)
 ** minimum space between numbers is 0.40" (10mm)

2.5" (63mm)
minimum

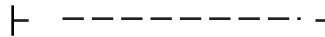

4" (101mm)

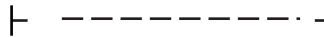

4" (101mm)

2.5" (63mm)
minimum

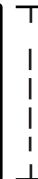

2.5" (63mm)
minimum

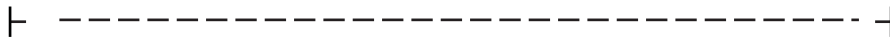

12" (305mm)

5.5" (140mm)
minimum

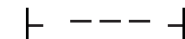

1.67" (42mm)

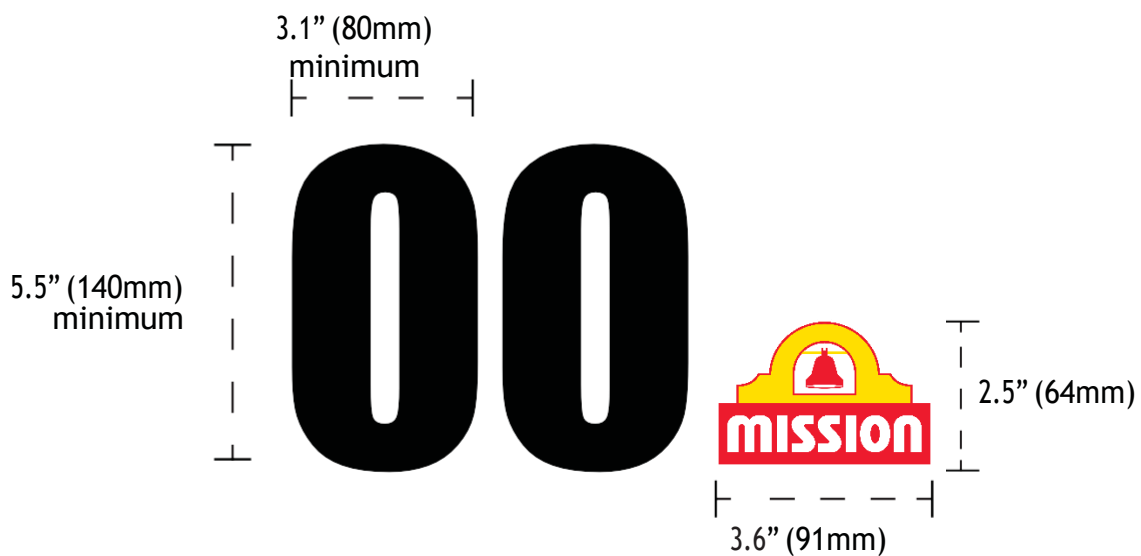
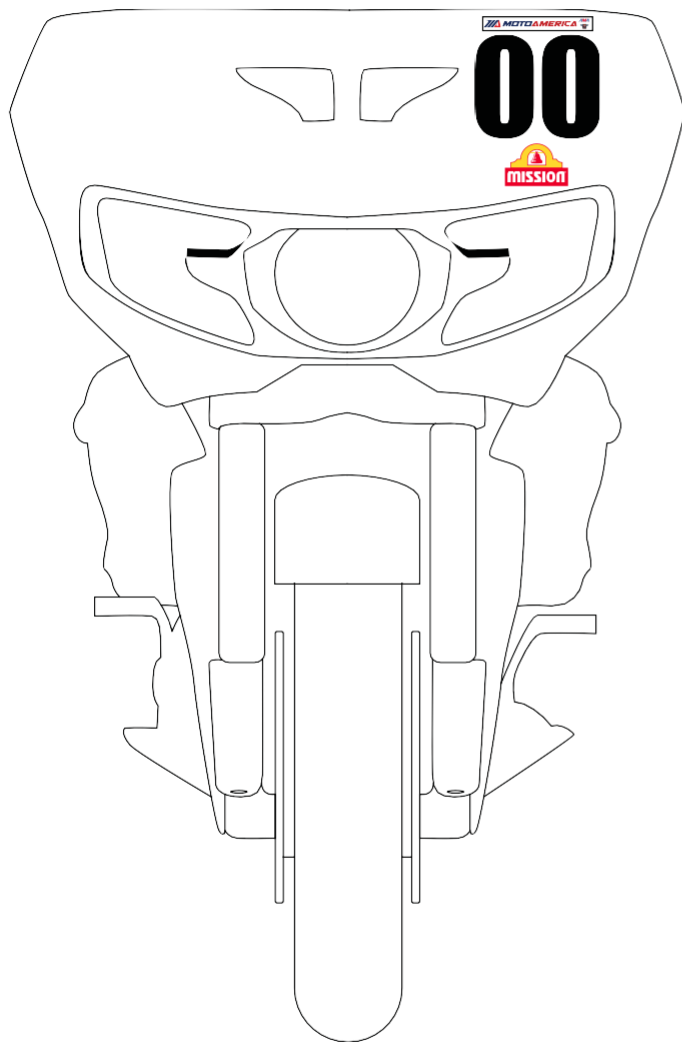

* minimum stroke is 0.75" (20mm)
** minimum space between numbers is 0.40" (10mm)

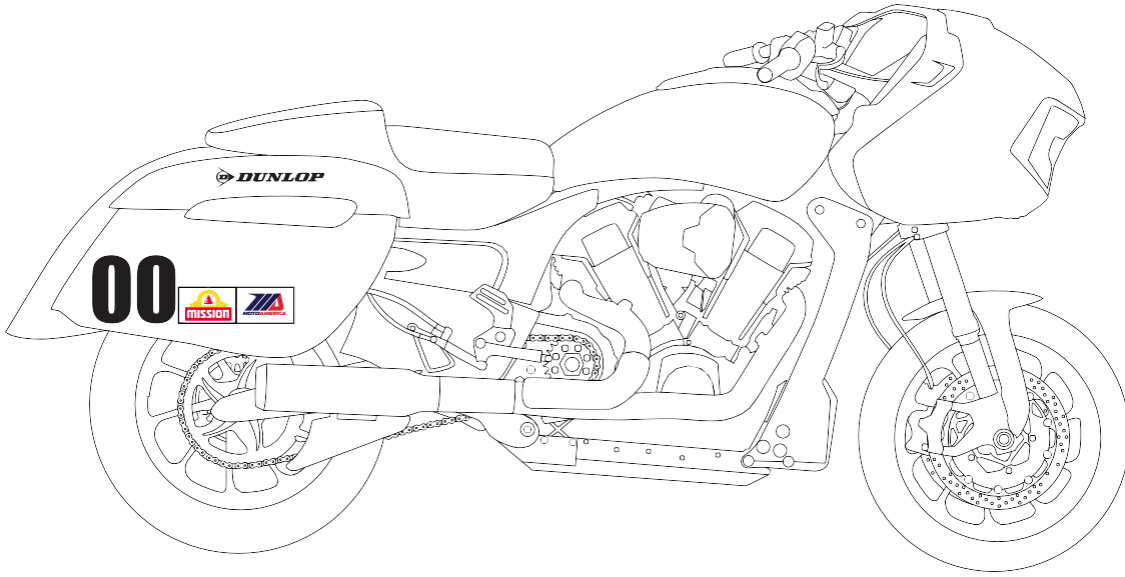

2.75" (70mm)
minimum

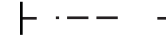

4.75" (120mm)
minimum

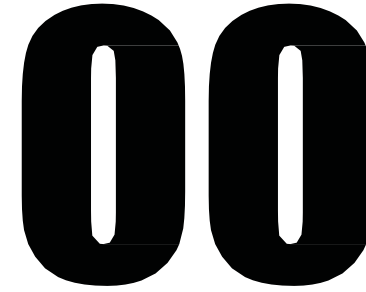
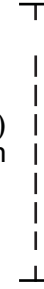

* minimum stroke is 0.75" (20mm)
** minimum space between numbers is 0.40" (10mm)

2.5" (63mm)
minimum



2.5" (63mm)
minimum



4" (101mm)

4" (101mm)

2.5" (63mm)
minimum



12" (305mm)

5.5" (140mm)
minimum



1.67" (42mm)



RIDER SUIT

SERIES PARTNER: 4.5" X 1.7"

MOTOAMERICA: 4" X 2"

DUNLOP (FRONT): 4.82" X 1"

DUNLOP (REAR): 10" X 2.03"

AMA/FIMNA: 5" X 1.22"

*The series partner requirements will be released if required.
All teams must leave this space available.

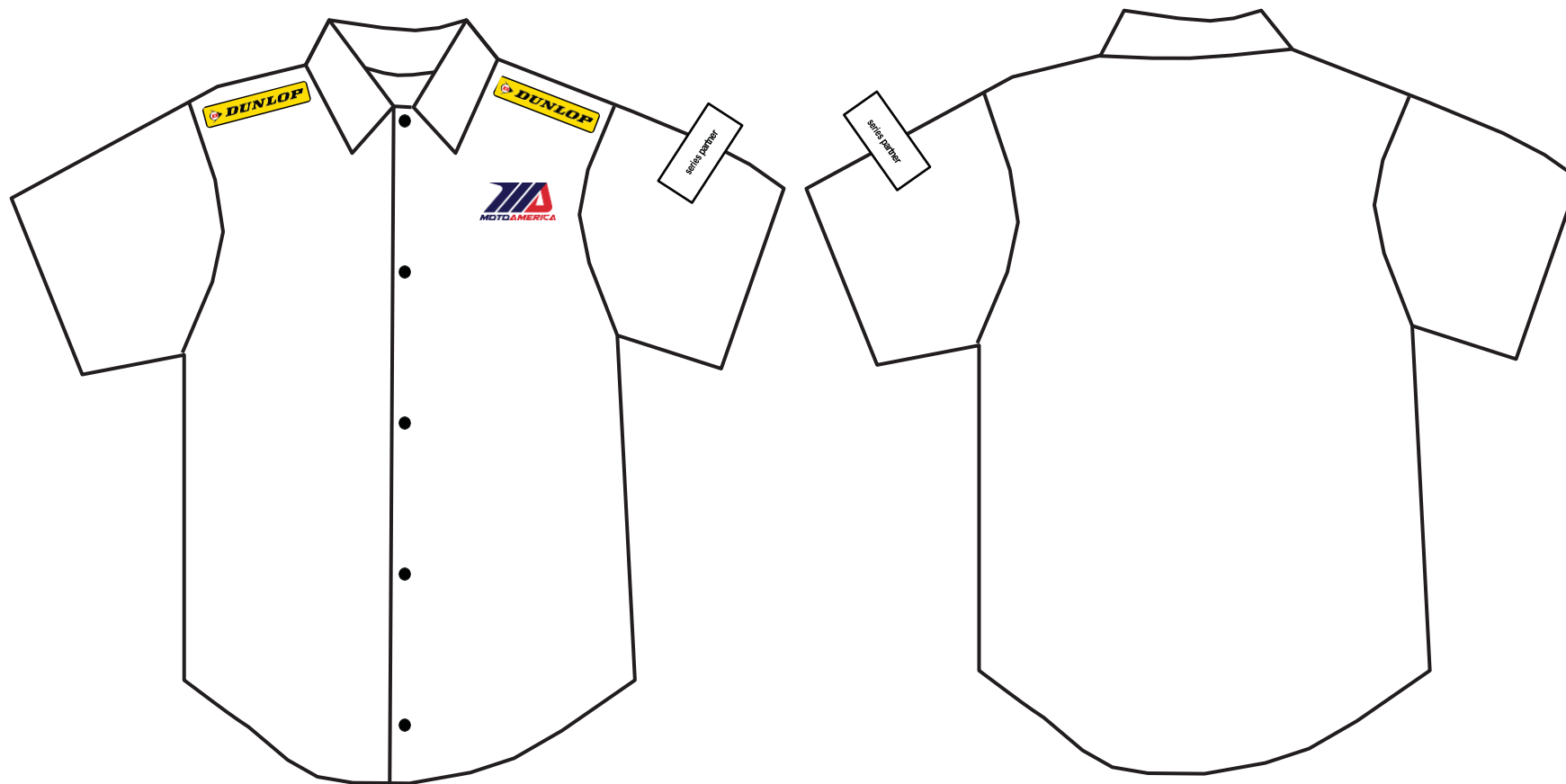

TEAM SHIRT

LOGOS ARE REQUIRED FOR COMPETITION

SERIES PARTNER*: 4.5" X 1.75"

MOTOAMERICA SERIES LOGO 4" X 2" DUNLOP

(FRONT): 4.82" X 1"

*The series partner requirements will be released if required.
All teams must leave this space available.